

Air Humidity Control

Installation, Operation and Maintenance Manual AIR DEHUMIDIFIER DESICCANT ROTOR TYPE

DFRD SERIES



According to the current European Union Rules on Machinery Safety, the reading of these instructions is **Imperative** before installing the unit.

INDEX

1. Introduction	2
1.1 Operating instructions	2
1.2 Typographic distinctions	2
2. Safety notes	2
2.1 General	2
2.2 Operational safety notes	2
3. Transport	3
3.1 General	3
3.2 Packing	3
3.3 Interim storage	3
3.4 Check for complete and correct delivery of goods	3
4. General description	4
4.1 Background	4
4.2 The desiccant wheel. Operating principle whit integral heat recovery	4
4.3 Dehumidifier main components identification	5
4.4 The PTC heater	6
4.5 Regulation and control	6
4.6 Options and ancillary components	7
5. Installation	7
5.1 Location of the unit	7
5.2 Service Areas	7
5.3 Air duct connections	8
5.4 Electric mains connections	9
5.5 Control equipment locations and connections	9
6. Start up	9
6.1 Unit start up	9
6.2 Stopping the unit	9
7. Maintenance	10
7.1 Preventative maintenance	10
7.2 Corrective maintenance	10
7.3 Desiccant wheel service	10
8. Fault finding	11
9. Overall dimensions	12
10. General technical data sheet	13
11. Spare parts list.	14
12. Wiring diagrams	15
12.1 Wiring diagram DFRB/DFRD-016-E	15
12.2 Wiring diagram DFRB-020/026-E	16
12.3 Wiring diagram DFRB/DFRD-036/045-E	17
12.4 Wiring diagram DFRB/DFRD-060/090-E	18
Conformity declaration	21
Warranty	22

Installation, Operation and Maintenance Manual

Desiccant Rotor Type Air Dehumidifiers DFRD series

1. Introduction.

Dear customer,

The FISAIR dehumidifier is our answer to today's technical requirements. It satisfies them by means of its operational safety, its operational comfort and its economic efficiency.

To be sure of operating your FISAIR dehumidifier efficiently please read these Operation and Maintenance Instructions.

Use the steam humidifier only in proper and safe conditions, paying attention to all notes in these instructions.

If you have any questions...please contact us:

Fisair S.L.

Phone (34) 91 692 15 14

Fax (34) 91 691 64 56

or your local dealer

1.1 Operating instructions.

The correct use of the air dehumidifier also includes adherence to our installation, dismantling, refitting, commissioning, operation and maintenance instructions as well as taking correct disposal steps.

Only qualified and authorised personnel may operate the unit. Persons transporting or working on the unit, must have read and understood the corresponding parts of the Operation and Maintenance Instructions and specially the chapter "Safety notes". Additionally, operating personnel must be informed of any possible dangers. You should place a copy of the Operation and Maintenance Instruction at the unit's operational location (or near the unit).

1.2 Typographic distinctions.

- Enumeration with preceding heading: General enumeration.
- » Enumeration with preceding double chevron: Work or maintenance steps that must be followed sequentially.

Sequential step to be checked.

2. Safety notes.

2.1 General.

These safety notes are required by law. They are for your protection and to prevent accidents.

Warning notes and safety symbols:

The following safety symbols shown in the text will warn about dangers and danger sources. Get familiar with these symbols.



Attention: Not observing this warning can lead to injury or danger to your life and/or damage to the unit.



Attention, Voltage: Dangerous electrical current. Not observing this warning can lead to injury or danger to your life.



Note: Materials/operational equipment; must be handled and/or disposed of according to the law.



Note: Further explanation or cross-references to other sections of the text in the Operation and Maintenance Instructions.

2.2 Operational safety notes.

 In General:

Observe all safety and warning notices.

If there should be malfunctions, shut down the unit immediately and secure against being restarted. Faults should be rectified immediately.

During repair work, guarantee operational safety of the unit by using qualified personnel.

Only use original FISAIR spare-parts.

For the effective operation of this unit refer to any national regulations restricting or governing its use.

 Accident prevention regulations:

Observe the accident prevention regulations:

Installation, Operation and Maintenance Manual

Desiccant Rotor Type Air Dehumidifiers DFRD series

"Electrical Installation and Electrical Equipment" or equivalent national codes. In this way you can prevent injury to yourself or others.

 Operation of the unit.

Do not impair the safety of the unit.

Periodically check all protection and warning devices for proper functioning.

Safety equipment is not to be removed or put out of operation.

 Installation, dismantling, maintenance and repair of the Unit.

Turn off power, when doing maintenance work or repairs to the unit.

Extensions to the unit or installation of additional equipment is only allowed after obtaining written approval from the manufacturer.

 Electrical parts.

Work on electrical parts must be carried out by qualified electricians.

Turn off the power and secure against restart when working on electrical parts.

Immediately turn the unit off when faults occur in the electrical energy supply.

Only use original type fuses of correct rating.

Make periodical checks of the electrical equipment.

Defects, like loose connections or burned cables must be repaired immediately.

Test all installed protective devices after installation or repairs (e.g. grounding).

3. Transport.

3.1 General.

 Note: Transport the air dehumidifier carefully. Prevent damage from careless loading and unloading and avoid the use of unnecessary force.

3.2 Packing.

 Note: Observe the pictograms displayed on the package.

3.3 Interim storage.

During storage, keep the unit dry and protected from frost.

3.4 Check for complete and correct delivery of goods.

Upon receipt of the unit, make sure that:

 Type and serial number on the name plate correspond to the order and supply information,

 Equipment is complete and in perfect condition.

 Note: Immediately file a written claim with your shipping agent in case of transport damage or missing parts.

4. General description.

4.1 Background.

Modern standards concerning human comfort and the environmental requirements for manufacturing, storage & preservation of products and materials, make increasing demands on the control of moisture content in the working environment.

Where the natural or treated environment have an ambient condition holding more water vapour than the specified or desirable conditions, it is necessary to integrate equipment which can reduce humidity to the desired level.

FISAIR ROTARY DESICCANT DEHUMIDIFIER provides the solution

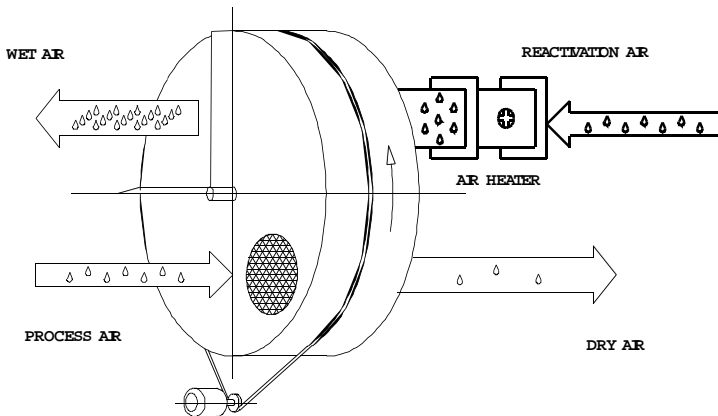

The FISAIR dehumidifier is simple to install, reliable in operation and will provide long lasting humidity control at a reasonable running cost.

4.2 The desiccant wheel. Operating principle with integral heat recovery





FISAIR dehumidifiers operate on the adsorption property of a desiccant synthesised activated silica gel manufactured into a cylindrical wheel shape with multiple axial channels.

In DFRD series the face of the cylinder is divided in two zones:

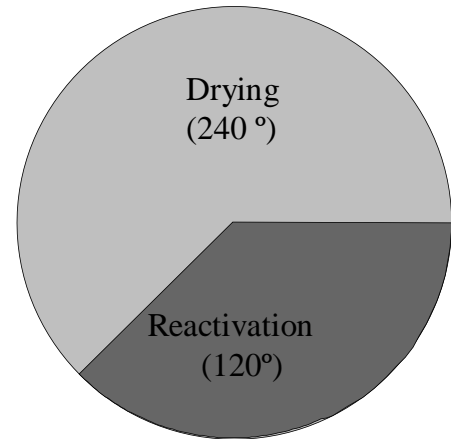
-  The Process Air Zone occupies 240 degrees approximately of the circle's face. In this section the desiccant removes moisture from the process air passing through the rotating desiccant cylinder.
-  The Reactivation Air Zone occupies 120 degrees approximately of the circle's face. In this section the reactivation air passes counterflow, previously heated to a temperature enough to open the desiccant pores, removing moisture from the desiccant.



-  Process air zone: 180°.
-  Reactivation air zone: 90°.
-  Heat recovery zone: 90°.

A gear motor via a pulley and driving belt rotates the cylinder at a low speed to provide a continuous and uniform operation, with a low energy consumption.

Perimetric and radial air seals separate air circuits and prevent air loss to ensure maximum performance.

4.3 Dehumidifier main components identification.

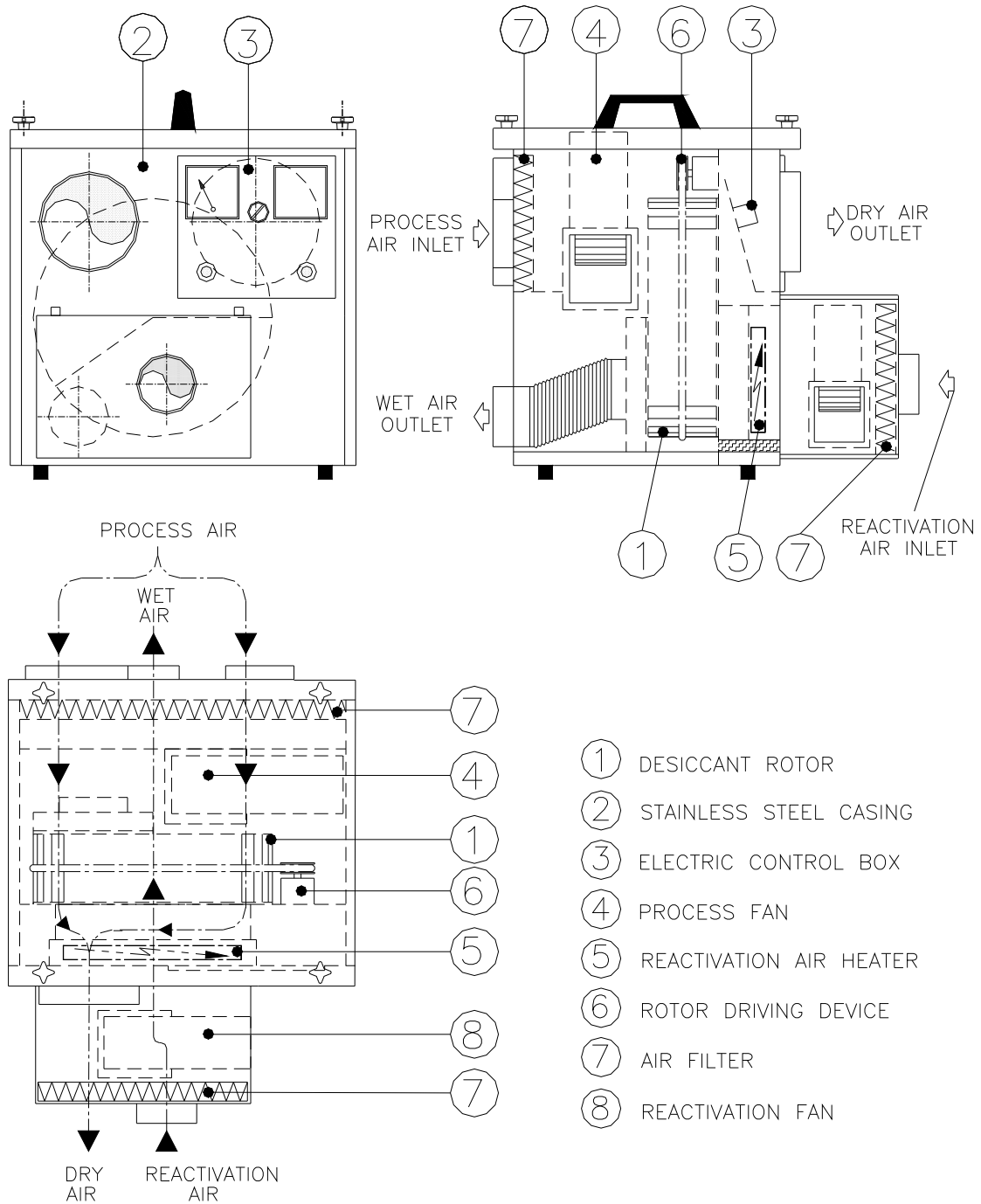

The above schematic drawing shows the FISAIR series DFRD dehumidifiers main components disposition as well as the air flow diagrams.

These models have relative low air flow and they incorporate two direct driven single ear centrifugal fan that moves the process/dry air as well as the reactivation/wet air respectively.

The face of the cylinder is divided in two zones, one is for the process air and the other for a heated auxiliary air stream to reactivate the desiccant. Thus a large surface area is presented to the air streams ensuring that a rapid drying process takes place.

Dry air and wet air outlets are made also with circular standard connections.

Installation, Operation and Maintenance Manual

Desiccant Rotor Type Air Dehumidifiers DFRD series

The unit electrical components are disposed into an enclosure with a folding cover located at the upper right front of the unit that can be accessed loosening the screws. The following items can be found in the front:

- ✎ One ammeter to show the reactivation heater current.
- ✎ One on/off switch with lighting indicator.
- ✎ Two cable conduits for the electric mains and the hygostat connection cables and/or remote on/off.
- ✎ In 3-phase models, an isolating switch.

The driving motor, fan and filter are easily accessible by dismantling the upper cover of the unit, fixed by T-knob screws, that can be tighten or loosen by hand.

The air heater is located at the bottom central part of the unit. This can be accessed dismantling the front protection cover which acts also as reactivation air deflector.

4.4 The PTC heater.

FISAIR DFRB series dehumidifiers use a PTC (Positive Temperature Coefficient) heater to heat the reactivation air with aluminium fins instead of a conventional electric resistance heater.

PTC heater is a semiconductor with variable electric resistance depending on its surface temperature. It is a ceramic polycrystalline compound, basically Barium Titanate with self temperature limitation. When connected to mains the semiconductor surface reaches a maximum temperature of 230° C (aprox.), absorbing a variable electric power depending on the air flow that crosses through it. Typical operating diagrams of these heaters are:

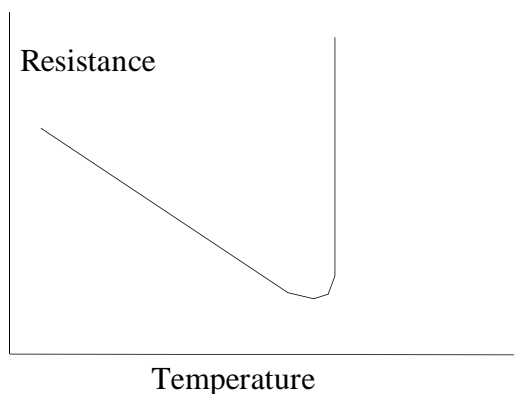

Resistance-Temperature Diagram

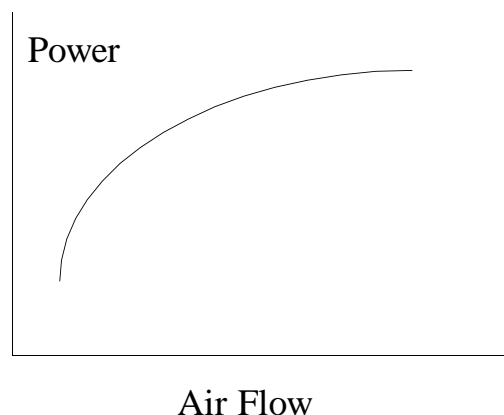

Power - Air Flow Diagram

PTC heater surface temperature self limitation effect provides the following advantages:

- » Since the manufacture materials are designed to support the highest surface temperature, fire risk is limited even without air flow.
- » The harmful atmospheric dust combustion doesn't happen.
- » A limiting thermostat to protect heater is not necessary.
- » Since dehumidification capacity is proportional to reactivation power and through the PTC heater this is proportional to the heated air flow, its reduction will proportionally decrease the unit capacity. This effect is immediately and easily noticed at the integral ammeter of the unit when the wet air discharge duct is strangled or obstructed.

4.5 Regulation and control.

As a consequence of the PTC heater operation explained above, dehumidifier DFRB drying capacity can be regulated in two different ways:

- ✎ On-Off Control: When you use the hygostat terminals marked as H1 on wiring diagram, if the circuit is opened the PTC heater is switched off. The air on the unit keeps on blowing but it is not dehumidified.





When using connection marked as H2 on wiring diagram, if the circuit is opened the unit is completely switched off.

- ✎ Note: The hygostat must have a 10 A electric cut-off resistive capacity. Otherwise an auxiliary relay must be installed.

 Proportional Control.- Other way to reduce the air heater power consumption and consequently the drying capacity of the unit, is to install a regulation damper in the wet air discharge duct. If the damper is driven by a proportional humidity controller, the dehumidifier capacity will be proportionally controlled in a modular way.

4.6 Options and ancillary components.

On demand, DFRB series of FISAIR dehumidifiers can be provided with:

-  Control Hygrostat On-Off.
-  Runtime Counter.
-  Manually or motor driven air flow regulation dampers.
-  Wall mounting or self carrier base.

5. Installation.

5.1 Location of the unit.

Before installing FISAIR dehumidifiers the following points should be considered

- » If the dehumidifier has to be stored for a significant period prior to installation it should be protected from external damage and dust and construction material.

 Note: In the case of outdoor storage, weatherproof covers should be employed.

- » The FISAIR DFRB dehumidifier is designed for internal installation, for outdoor use please apply to your local representative for special construction details.
- » Once final location is defined ensure that there is enough space for servicing to be carried out. Take care to ensure that ducting connections are made without stressing the unit.

5.2 Service Areas.

Using the attached dimensioned drawings of the relevant model, consider periodically:

- » Air filters must be cleaned or changed.
- » The desiccant wheel faces should be inspected and cleaned and the air seals adjusted as necessary.
- » Driving belt should be checked for fatigue and its tightness checked.
- » Check the operation of fans and motors and the reactivation heater. In case of failure, repair or replace.
- » Check the components in the control box, service or change as necessary.

 Note: To service/replace the main inside components, dismantle the top cover and sided plates. This will provide enough space to service everything.

Pay attention to avoid that ducting connections and unit location do not prevent servicing.

5.3 Air duct connections.

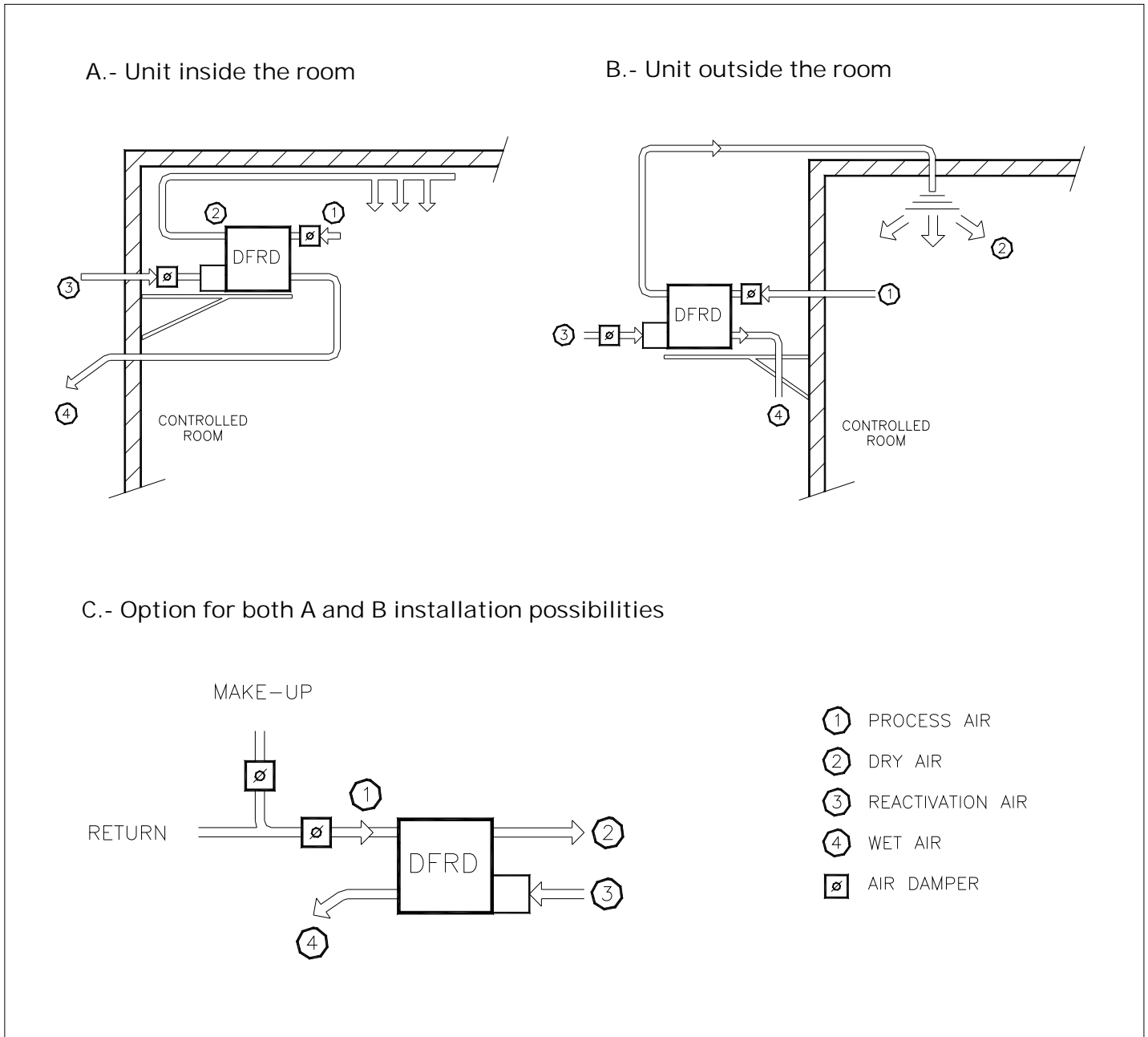

Different operation options of the unit as 'All Fresh Air' or 'Partial/Total Recirculation' systems and the possibility of mounting the unit inside or outside of the site which humidity is being controlled, determine the use of one of the above duct mounting diagrams:

 In the diagrams are indicated two regulation dampers located at wet and dry air ducts used to adjust each circuit air flow and consequently the dehumidifier capacity.

Additionally, in the Partial/Total Recirculation diagrams you can see a third damper located in one of the process air inlets that can be used to over pressure the controlled site, minimising air infiltration from adjacent rooms.

The static pressure available for ducts can be found in the unit data-sheet.

Also, the wet air duct must facilitate the draining of the condensing water produced when this air becomes cooler

due to heat transmission. To achieve this the duct must slope downstream and the wet air outlet must be placed as far as possible from the process air intakes, to avoid losses of performance.

5.4 Electric mains connections.



Attention: The dehumidifier works with medium electrical power and voltage and its connection to the mains must be done by qualified personnel and according to the applicable local electrical regulations.

The unit must be connected to the electrical network of the installation through a short circuiting and ground leakage protection line, with wires section/sensitivity as corresponds to the dehumidifier power.

5.5 Control equipment locations and connections.

The location and mounting instruction for the control equipment are normally specified by the corresponding supplier.

In case of On-Off Control using a Hygrostat you can choose between the complete unit switch off or the reactivation air heater switch off, as described before.

6. Start up.

6.1 Unit start up.

Once the ductwork has been completed and the equipment is connected to the electrical mains, as well as to the control equipment, proceed in this way:



Attention: Before using the control panel, verify that all mechanical elements can work freely and the unit has no installation debris inside.

- » Check that the air flow regulation dampers, if exist, are opened.
- » Check that hygrostat set point - if exists - is at least 10-15% lower than environmental humidity.
- » Check that electric mains is protected with a fuse adequate to the unit power.
- » Switch on the unit. Integral pilot must light. Fan starts operation and the ammeter reading reaches the upper limit due to the PTC heater consumption. PTC heater, like motors, have a consumption peak on starting 2 or 3 times the normal consumption.
- » Wait a few minutes allowing the desiccant wheel to rotate several times until drying and regeneration processes are stabilized. Check that dry air temperature is lightly higher than the process air temperature, and the wet air temperature is higher than the dry air temperature. Adjust air flows to specific requirements of each application.
- » Measure foreseen thermohygroscopic parameters. To reduce the unit capacity you have to strangle the wet air stream, this automatically reduces consumption indicated by the ammeter.

6.2 Stopping the unit.

The equipment can be stopped manually or automatically.

Manual mode:

- » Just operate the control switch to its "OFF" position.

Automatic mode:

- » The unit will be shut-off when jumper H2, shown in the wiring diagram, is open (this stops the unit totally). In case of opening jumper H1, the reactivation air heater is shut-off while the two motors keep on running.

7. Maintenance.

7.1 Preventative maintenance.

The Following service schedule can be used.

OPERATION	FREQUENCY
Filters cleaning	Weekly
Rotor driving check	Weekly
Fan impellers inspection	Monthly
Inner inspection (desiccant rotor surfaces) driving belt tension and absence of unexpected materials.	Every second month
Electrical consumption and terminals tightening	Every second month
General cleaning	Yearly

7.2 Corrective maintenance.

The (desiccant rotor type) FISAIR dehumidifiers series DFRB have a very simple design and their components should have very few problems.

The fans/motors are of standard manufacture and in case of electrical or mechanical damages any skilled serviceman may do the repairing. The PTC heaters can be easily changed or serviced when necessary (normally after a very long working period) like any other conventional air heater element (resistor).

Also, minor components like filters, dampers, driving belt and electric box components could be replaced after their useful life and the user will have to define the necessity of storing these parts, depending on their availability through local dealers.

7.3 Desiccant wheel service.

This is the only dehumidifier component that needs any special attention.

Concerning the mechanical operation, the rotor should not require attention for a very long time. Its rotation speed is so low (20-24 r.p.h.) that the bearings and desiccant material housing cannot suffer any mechanical damage normally. However, it is very important to verify periodically the correct operation of the driving device because it directly affects the drying process.

Regarding the water vapour adsorption process, the main rotor component, activated silicagel, works by fixing the water vapour molecules in its micropores in the process air stream, leaving them when the heated reactivation air stream passes through the rotor channels.

This process is not affected by the normal environmental air conditions, nor by accidents of the installation that can be expected (for example, water direct action on the rotor does not affect the material, which is also fireproof).

Usual dust deposits on rotor surfaces can be removed by vacuum or blowing as well as by washing (please contact your dealer for written method when needed).

8. Fault finding



Immediately switch off the dehumidifier if a fault occurs. Faults are only to be remedied by qualified personnel following the proper safety instructions.

Fault	Measures
The unit has stopped	Check the following points: <ul style="list-style-type: none"> • Electric mains are powered and the pilot lights on. If not, reset the mains protections. • If pilot lights on, check if the air has reached the hygostat set point. • If electric mains are powered, the hygostat demands operation and the unit is not operating, please ask the dehumidifier supplier for technical assistance, since electrical components checking is to be performed.
The unit works, but it does not perform as expected.	Check the following points: <ul style="list-style-type: none"> • Wet air duct is not obstructed. • Air filter is not too dirty • Desiccant wheel rotates softly and continuously, and the rotor surfaces are not obstructed. • The dry air outlet duct temperature is slightly higher than the process air duct, and the wet air duct temperature is higher than the dry air duct. • Dry air and Wet air flow. • If all this checking is successful, a measurement of the unit capacity must be performed as well as to review the single facility design parameters.

9. Overall Dimensions

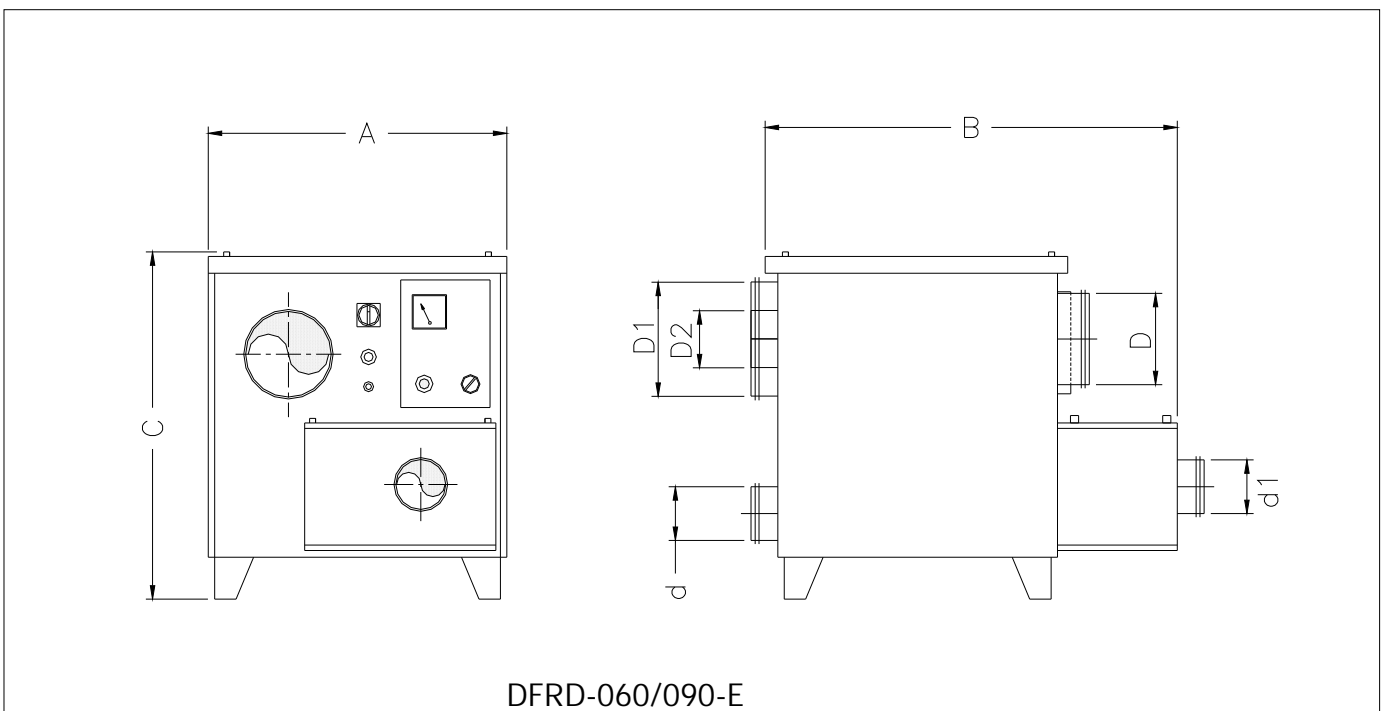
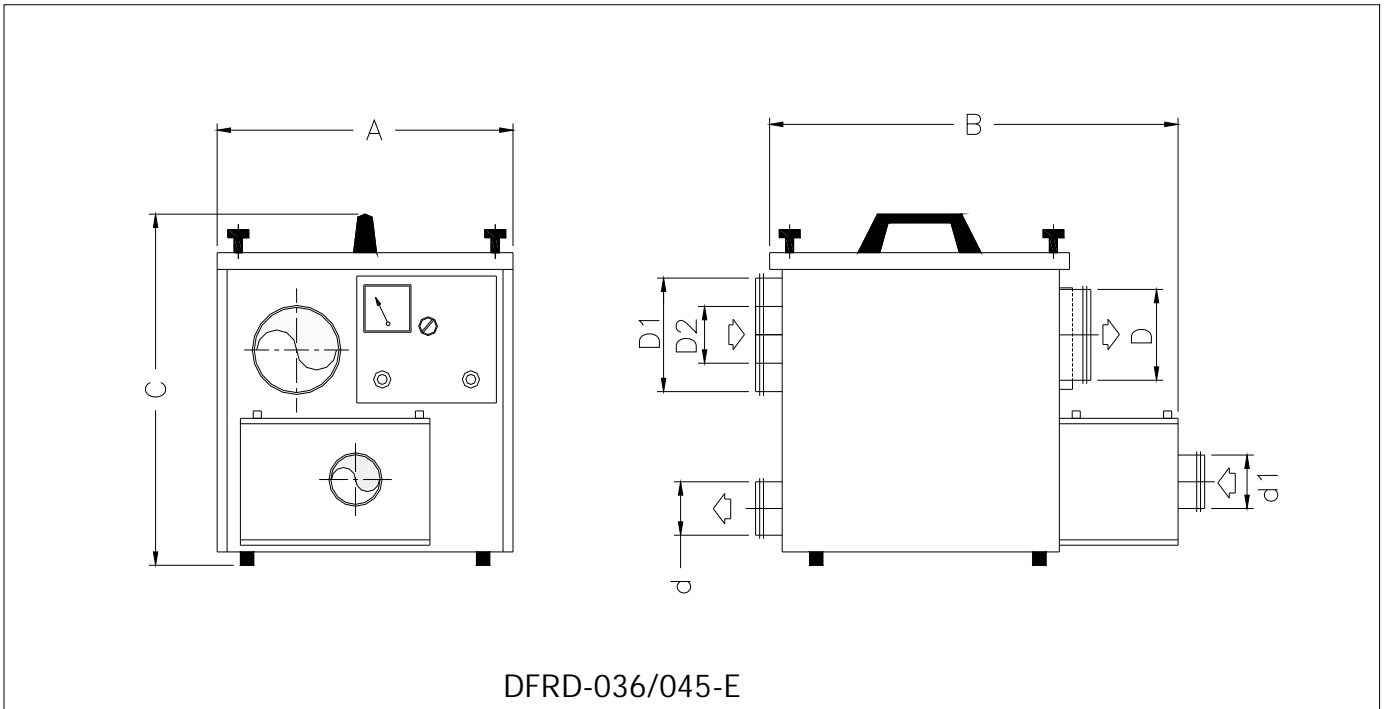

UNIT MODEL	OVERALL DIMENSIONS			CONNECTION TO DUCTS DIMENSIONS					WEIGHT APROX. (kg)
	A	B	C	D	D1	D2	d	d1	
DFRD-036/045-E	510	660	525	150	200	100	100	100	45
DFRD-060/090-E	695	955	785	200	250	125	150	200	85

Installation, Operation and Maintenance Manual

Desiccant Rotor Type Air Dehumidifiers DFRD series

10. General Technical Data Sheet.

MODEL		DFRD-036-E	DFRD-045-E	DFRD-060-E	DFRD-090-E
Process/Dry Air Flow		300 m ³ /h	350 m ³ /h	500 m ³ /h	700 m ³ /h
Available Pressure For Ducting		300 Pa	400 Pa	350 Pa	470 Pa
Reactivation/Wet Air Flow		90 m ³ /h	100 m ³ /h	150 m ³ /h	210 m ³ /h
Available Pressure For Ducting		100 Pa	100 Pa	320 Pa	320 Pa
Nominal Drying Capacity (*)		1,4 kg/h	1,7 kg/h	3 kg/h	4,2 kg/h
Total Power Supply		2,9 kW	3 kW	5 kW	7 kW
Nominal Current		11 A	12 A	8 A	11,5 A
Process motor power		400 W	400 W	190 W	290 W
Reactivation motor power		80 W	80 W	240 W	240 W
Reactivation Heater Power	Nominal Power	2,4 kW	2,5 kW	4,5 kW	6,5 kW
	Max. Built-in Power	3,1 kW	3,1 kW	7,2 kW	9,3 kW
Electrical Supply		230V/I+N/50-60Hz	230V/I+N/50-60Hz	400V/III+N/50-60Hz	400V/III+N/50-60Hz

(*) Nominal capacity: 20°C and 60% H.R.

Capacity diagram (*)

Setlet parameters:

- Process/Reactivation air temperature: 20°C
- T Reactivation heater according to nominal power
- Equal Process/Reactivation air humidity content

(*) At other operating conditions please ask for the corresponding performances.

DFRD-036-E

DFRD-045-E

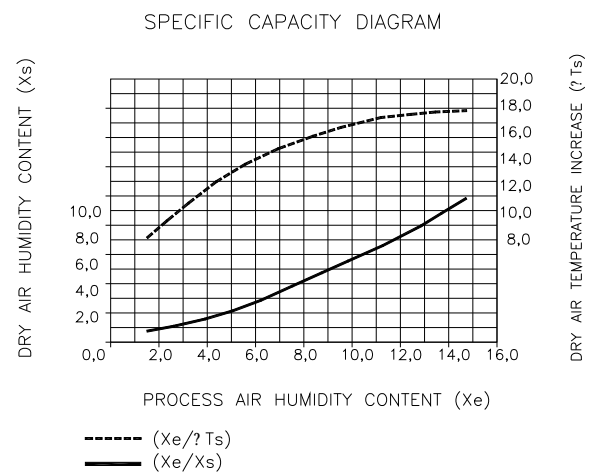
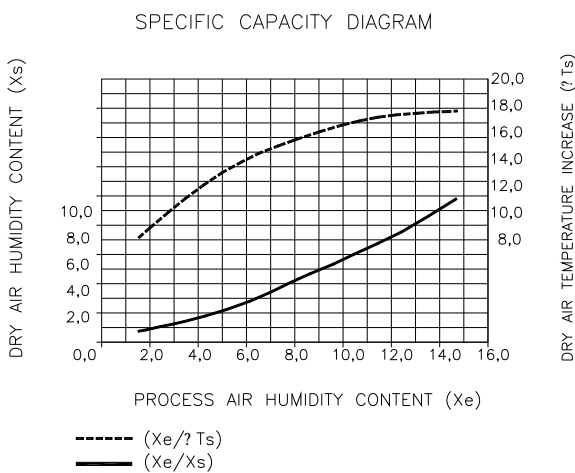

Installation, Operation and Maintenance Manual

Desiccant Rotor Type Air Dehumidifiers DFRD series



DFRD-060-E

DFRD-090-E

SPECIFIC CAPACITY DIAGRAM

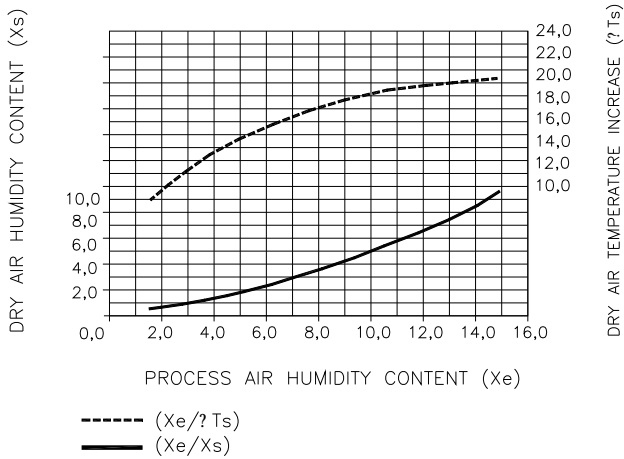

SPECIFIC CAPACITY DIAGRAM

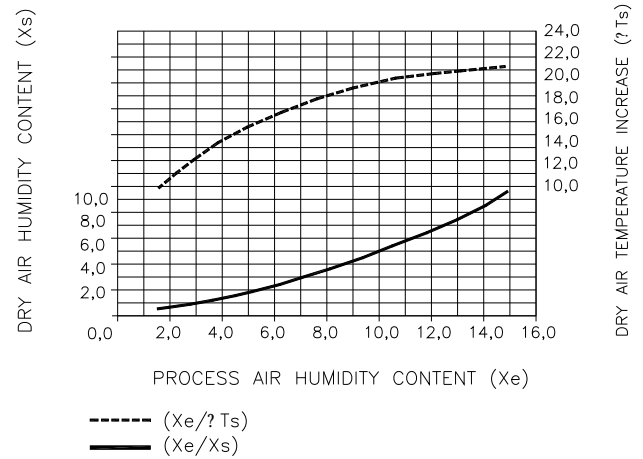

11. Spare Parts List.

ELEMENT	MODEL							
	DFRD-036-E		DFRD-045-E		DFRD-060-E		DFRD-090-E	
	Code	Units	Code	Units	Code	Units	Code	Units
Desiccant rotor	65110020	1	65110025	1	65110030	1	65110035	1
Silicone seal	62410035	1,3 m	62410035	1,3 m	62410035	1,5 m	62410035	1,5 m
Felt seal	62410055	1,2 m	62410055	1,2 m	62410055	1,8 m	62410055	1,8 m
Drive motor	65220015	1	65220015	1	65220005	1	65220005	1
Driving belt	61410030	1	61410030	1	61410035	1	61410035	1
Pulley	61600050	1	61600050	1	61600055	1	61600055	1
Process Air Fan	63000110	1	63000110	1	63000120	1	63000125	1
Reactivation Air Fan	63000095	1	63000095	1	63000105	1	63000105	1
Air Filter	13500005	1	13500005	1	65420000	1	65420000	1
PTC Heater element	65020020	1	65020020	1	65020005	3	65020020	3
A-meter	20640005	1	20640005	1	20640005	1	20640005	1

Installation, Operation and Maintenance Manual

Desiccant Rotor Type Air Dehumidifiers DFRD series

12. Wiring diagrams.

12.1 Wiring diagram DFRB/DFRD-016-E.

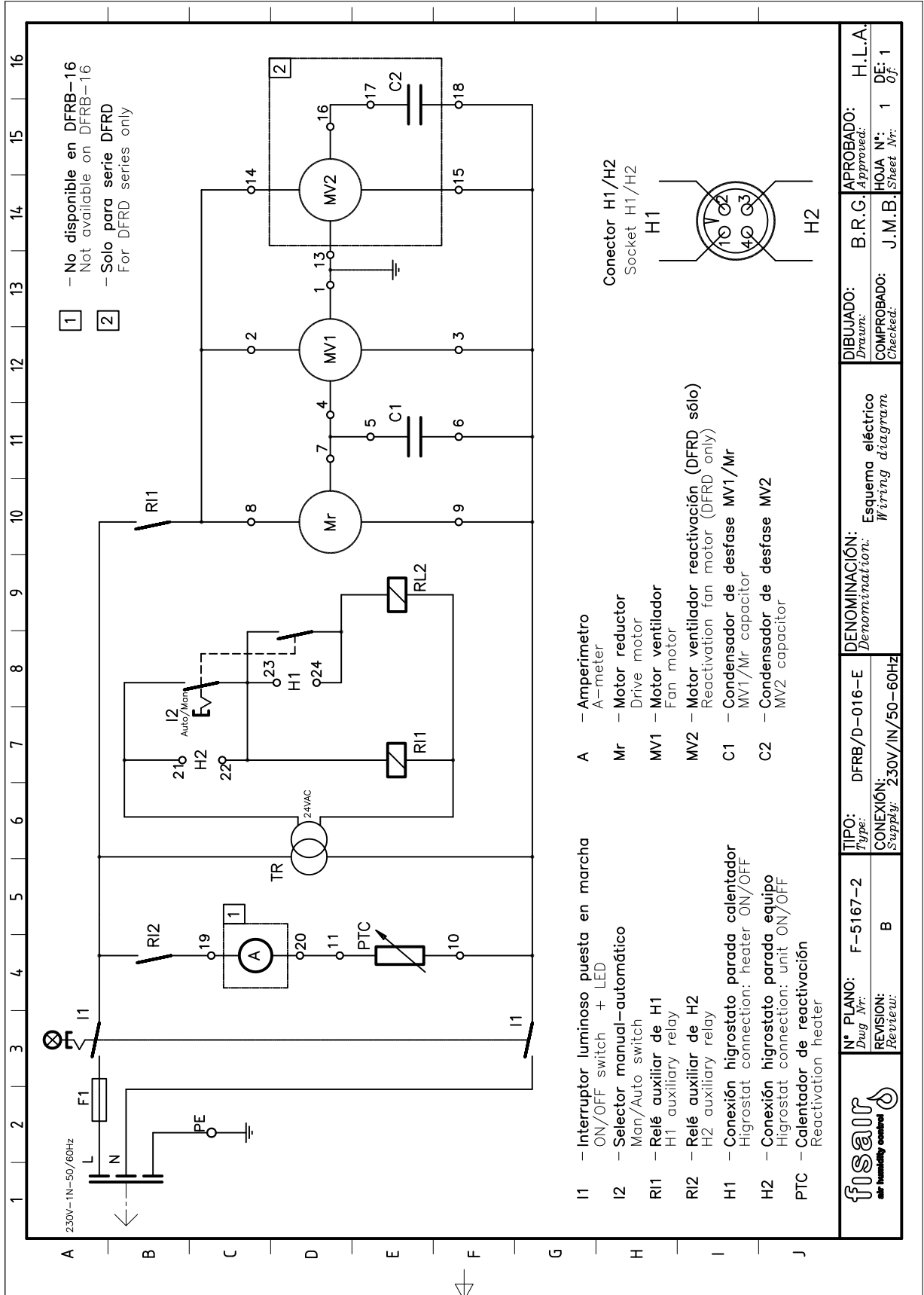

Installation, Operation and Maintenance Manual

Desiccant Rotor Type Air Dehumidifiers DFRD series

12.3 Wiring diagram DFRB/DFRD-036/045-E.

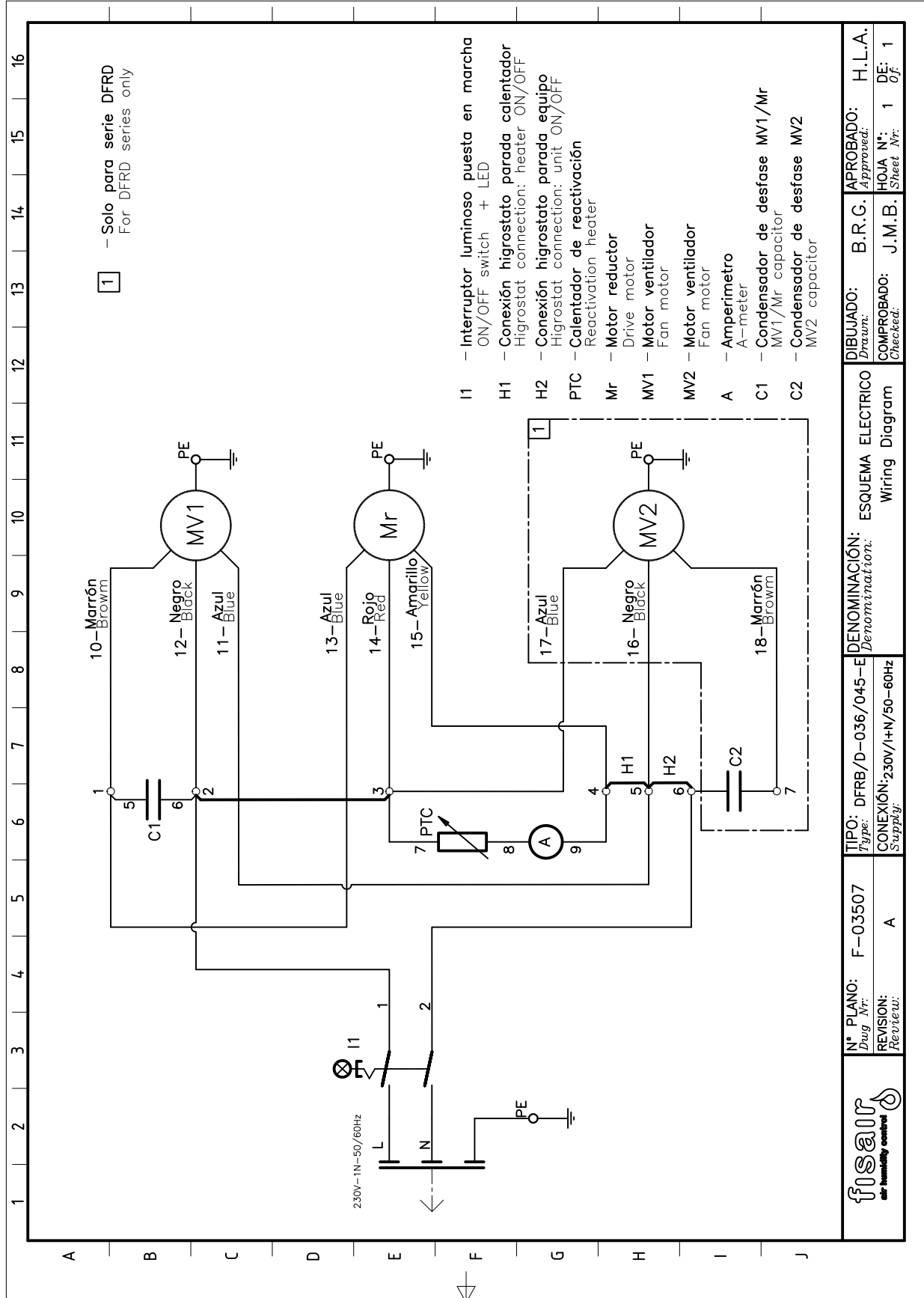

12.4 Wiring diagram DFRB/DFRD-060/090-E.

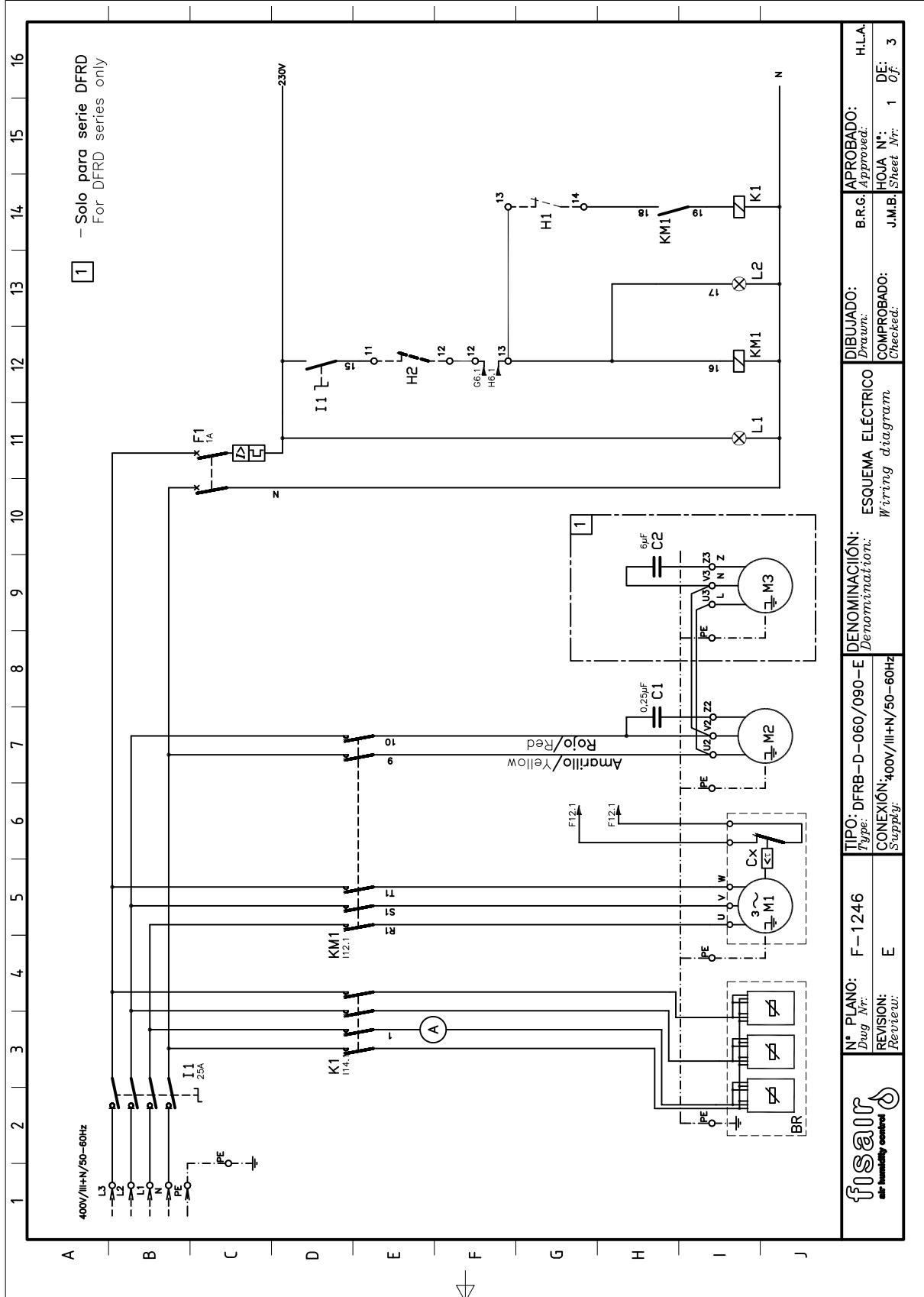

Installation, Operation and Maintenance Manual

Desiccant Rotor Type Air Dehumidifiers DFRD series

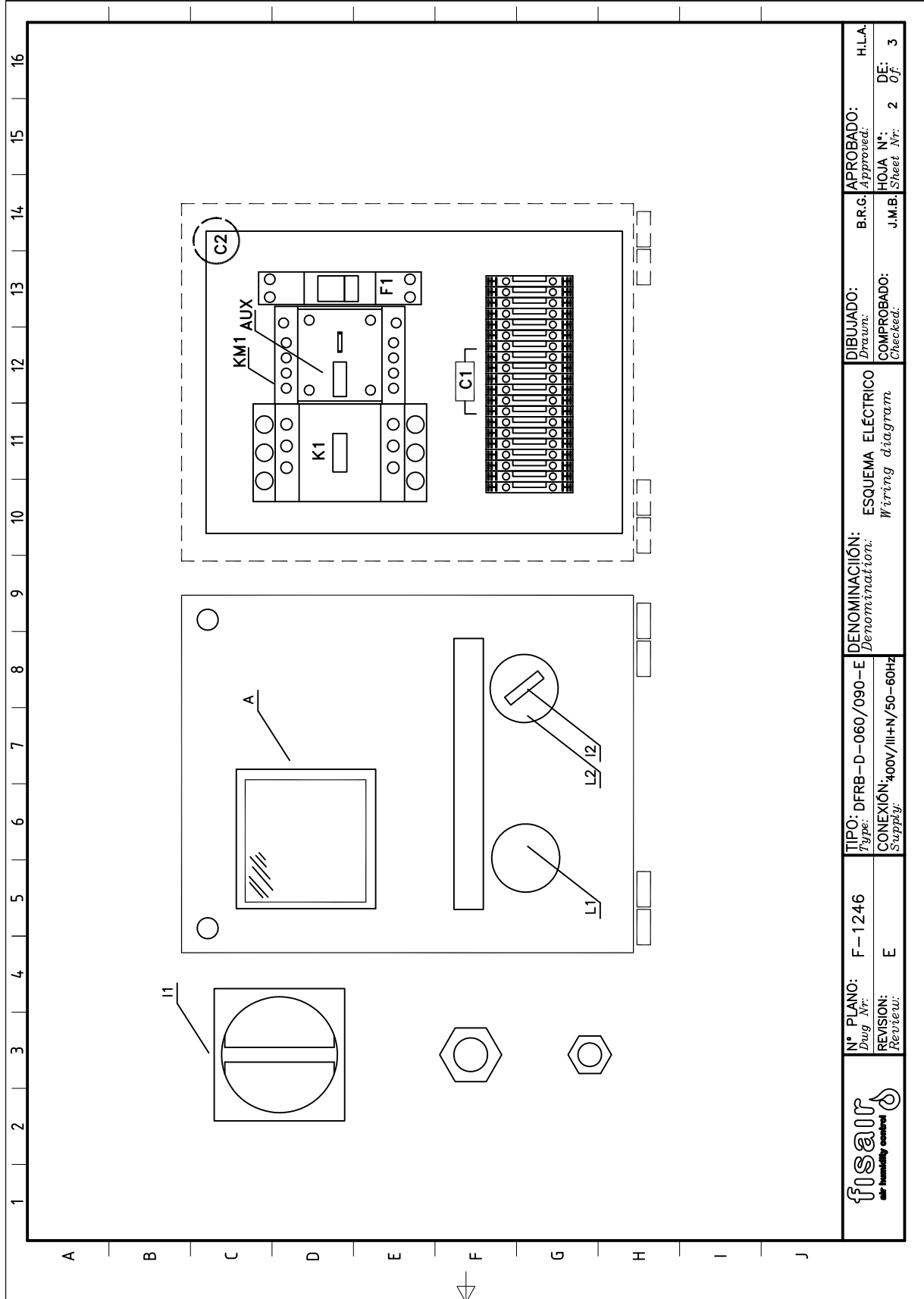



DECLARACIÓN CE DE CONFORMIDAD
EC CONFORMITY DECLARATION
EG KONFORMITÄTSERLÄRUNG
DECLARATION CE DE CONFORMITÉ



Departamento de Dirección Técnica
Technical Direction Department

Abteilung von der technischen Leitung
Département de Direction Technique



FISAIR S.L.
C/ Uranio, 20 (Pol. Ind. Aimayr)
28330 San Martín de la Vega (Madrid) ESPAÑA
☎ Tfº (34) 916921514
☎ Fax (34) 916916456

DECLARAMOS Bajo nuestra única responsabilidad que el deshumidificador de aire:
WE DECLARE, under our own responsibility that the air dehumidifier:
Unter unserer ausschließlicher Verantwortung ERKLÄREN WIR, daß der Luftentfeuchter:
NOUS DECLARONS, sous notre unique responsabilité que le deshydrateur d'air:

MARCA/BRAND/MARKE/MARQUE:

SERIE/SERIES/REIHE/SÉRIE:

FISAIR

DFRD

Se adapta a las normas:
Meets the regulations:
Den Normen entspricht:
S'adapte aux normes:

* EN 12100: 2012
* EN 60204-1: 2007
* EN 61000-6-1: 2007
* EN 61000-6-3: 2007
* EN 13857: 2008

Es conforme a los requisitos esenciales de las Directivas:
Conforms to the essential requirements of the Directives:
Und den von den Richtlinien aufgestellten Grundvoraussetzungen Rechnung trägt:
Et est conforme aux conditions essentielles des Directives:

* 2006/42/CE
* 2004/108/CE
* 2006/95/CE

Con exclusión de responsabilidades sobre las partes o componentes adicionales o montados por el cliente.

With no liability for the parts or components added or assembled by the customer.

Unter Ausschluß der Verantwortung über die vom Kunden bereitgestellten und/oder angebauten Teile.

Avec exclusion des responsabilités concernant les parties ou les composants ajoutés ou assemblés par le client.

Departamento Dirección Técnica/Technical Direction Department/Département de Direction Technique/Abteilung von der technischen Leitung:

Hugo J. López Álvarez
San Martín de la Vega, marzo 2014



FISAIR S.L. WARRANTY POLICY



Technical Direction Department
Departamento de Dirección Técnica



FISAIR S.L.
C/ Uranio, 20 (Pol. Ind. Aimayr)
28330 San Martín de la Vega (Madrid) SPAIN
☎ Tfº (34) 916921514
☎ Fax (34) 916916456

Two-year Limited Warranty

FISAIR warrants to the original purchaser that its products will be free from defects in materials and parts for a period of two (2) years after installation or twenty-seven (27) months from the date FISAIR ships such product, whichever date is the earlier.

If any FISAIR product is found to be defective in material or assembly during the applicable warranty period, FISAIR's entire liability, and the purchaser's sole and exclusive remedy, shall be the repair or replacement of the defective product or part.

Warranty disclaimer

FISAIR shall not be liable for any costs or expenses, whether direct or indirect, associated with the installation, removal or reinstallation of any defective product.

The Limited Warranty does not include any consumer part such as joints, pulleys, filters or media.

FISAIR's Limited Warranty shall not be effective or actionable if:

- a) All related product invoices have been paid in time and terms.
- b) Unless there is compliance with all installation and operating instructions furnished by FISAIR, or if the products have been modified or altered without the written consent of FISAIR, or if such products have been subject to accident, misuse, mishandling, tampering, negligence or improper maintenance. Such situations could be an incorrect power supply connection, crashed with inappropriate objects, security protection devices unblocked and so.

Any warranty claim must be submitted to FISAIR in writing within the stated warranty period.

Parts Warranty

Defective parts may be required to be returned to FISAIR. In case any part is claimed as a faulty one, FISAIR will ask the customer to send the part back to the factory in order to analyze if the part is failing due to any of above referred actions (see warranty disclaimer) or due to effective part failing.

If the part must be replaced immediately, FISAIR will ship the part to the customer immediately and invoice the part with a 30 days delay payment for the faulty part to be returned. If the part is returned in this period, the part fail analysis would be made to emit a technical report for the warranty coverage based in this Warranty Statement document.

In case that the part is failing due to a lack of quality, FISAIR will credit this invoice in order to stop the payment. In case FISAIR does not receive the part in this period, or if the failure is due to the reasons covered in the Warranty disclaimer paragraph, the invoice will be effective.

In case any part from the product / shipment is missing, the customer should notify FISAIR before 3 days from the shipment date of arrival.



FISAIR S.L. WARRANTY POLICY



Technical Direction Department
Departamento de Dirección Técnica

Service Covered by Warranty

In case that there is any FISAIR product that should be serviced in order to recover its proper used designed, FISAIR will select the person (s) in charge of this operation. These qualified technicians should have the enough knowledge to service FISAIR units.

No company should practice a warranty service without the writing FISAIR notice giving the authorization to do it and if any cost should be cover by FISAIR should be advised in advance to the service job. In case that FISAIR should send FISAIR staff to solve the solution, trip expenses are not covered by the warranty.

FISAIR's Limited Warranty is made in lieu of, and FISAIR disclaims all other warranties, whether express or implied, including but not limited to any implied warranty of merchantability, any implied warranty of fitness for a particular purpose, any implied warranty arising out of a course of dealing or of performance, custom or usage of trade.

FISAIR shall not, under any circumstances be liable for any direct, indirect, incidental, special or consequential damages (including, but not limited to, loss of profits, revenue or business) or damage or injury to persons or property in any way related to the manufacture or the use of its products. The exclusion applies regardless of whether such damages are sought based on breach of warranty, breach of contract, negligence, strict liability in tort, or any other legal theory, even if FISAIR has notice of the possibility of such damages.

By purchasing FISAIR's products, the purchaser agrees to the terms and conditions of this Limited Warranty.

Extended Warranty

The original user may extend the term of the FISAIR Limited Warranty for a limited number of months past the initial applicable warranty period and term provided in the first paragraph of this Limited Warranty. All the terms and conditions of the Limited Warranty during the initial applicable warranty period and term shall apply during any extended term.

Each case should be valued in terms of type of product, equipment application, use and location of the product operation site.

Any extension of the Limited Warranty under this program must be in writing, signed by FISAIR, and paid for in full by the purchaser.

Hugo J. López Álvarez
San Martín de la Vega, junio 2013